

Manual

Electronic Heat Cost Allocator



Sontex 565

Sontex 566 Radio

Sontex 868 Radio

1. Specification

1.1 General Description

1.1.1 Type

The electronic heat cost allocators **Sontex 565 / 566 / 868** operate either according to the single sensor principle with start sensor or the double sensor principle. The device has been developed and approved in accordance with the European Standard *EN 834:2013*.

1.1.2 Design

The heat cost allocator consists of a microprocessor, a lithium battery, two temperature sensors, a heat conducting aluminium back plate, a multi-functional display and a plastic housing. The measuring circuit consists of the temperature sensors, the analogue-digital conversion, the reference resistance for standardising the measuring transformation and the microprocessor for accessing the radiator heat output. During each measuring the circuit tolerances are eliminated with a reference resistance and the heat cost allocator carries out an automatic self-test.

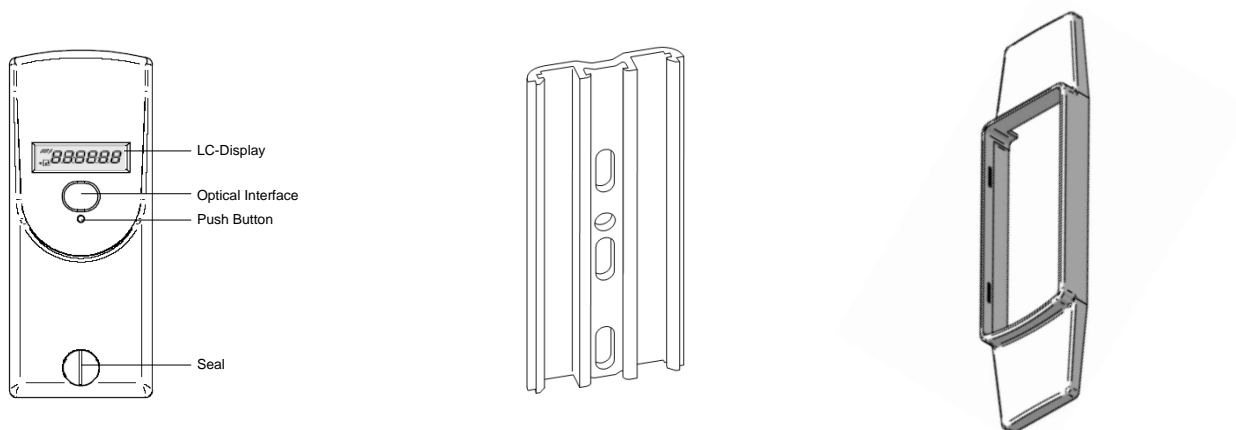

Standard aluminium back plate for nearly all existing bolts with common dimensions and mounting possibilities – thus easy installation

Snap-on blind to cover colour shadows for increased aesthetics

1.1.3 Characteristics

- Measuring by two temperature sensors, radiator and ambient temperature sensor (NTC-resistor).
- Optional measuring principle: 1 sensor mode with start sensor or two sensor mode.
- Unit scale or product scale.
- Recording of cumulated heat consumption on the annual set day.
- Recording of 144 monthly values and 18 half monthly values for cumulated heat consumption.
- Recording of 18 monthly values for the maximum radiator temperature.
- Optical interface for the readout of the data and programming

- For heat cost allocator **Sontex 566 Radio**, the Sontex radio system (**Supercom**) is a bidirectional system. Reading and programmable by radio.
- For heat cost allocator **Sontex 868 Radio**, the radio module comprises a unidirectional radio transmitter.
Two telegrams: short telegram, OMS compliant and long telegram for Walk-by reading.
- User-friendly operation by push button.
- 6-digit and high-contrast LCD display.
- Automatic commissioning during the mounting on the aluminium back plate (available when ordering).
- Check code for postcard mail-in method
- Possibility to connect a remote sensor on each version of heat cost allocator. The remote sensor will be automatically detected by the heat cost allocator.
- Remote sensor version with 2 m cable.
- Standard aluminium back plate for nearly all existing bolts with common dimensions and installation possibilities – thus easy installation (no cutting and welding of bolts necessary).
- Snap-on blind to cover colour shadows for increased aesthetics.
- Safe operation and fraud/manipulation detection.
- Lithium battery with a capacity of up to 10+1 year.
- Meets EN 834:2013.

1.1.4 Display

The heat cost allocator has a LCD-display with 6 large main digits on the right and 2 smaller digits on the left as well as two special symbols and one communication indicator. The main digits are separated by four decimal points. Below, please find the display segments:

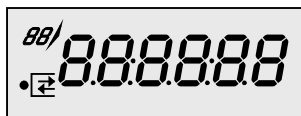

Display with all active segments

Normally, the heat cost allocators **565 / 566 / 868** are supplied with switched-off LCD-display. On request, the heat cost allocators can also be supplied with permanent LCD- display.

1.1.5 Electronics

The device has an electrical circuitry with an 8-Bit-CMOS-micro controller of the latest generation STM8L with extremely low current consumption operating at a voltage as from 1.8 V. The temperature measuring circuit with automatic self-calibration measures the discharging time of a capacitor. The accuracy of the measuring circuit is independent of the supply voltage.

1.1.6 Versions

Sontex 565 Standard:

- Heat cost allocator Sontex 565 with optical interface, standard device.
- Heat cost allocator Sontex 565 X with optical interface, standard device to substitute Kundo 201 / 202 devices.

Sontex 566 Radio (433.82 MHz):

- Heat cost allocator Sontex 566 with optical interface, standard device.
- Heat cost allocator Sontex 566 X with optical interface, standard device to substitute Kundo 201 / 202 devices.

Sontex 868 Radio wM-Bus (868.95 MHz):

- Heat cost allocator Sontex 868 with optical interface, standard device.

- Heat cost allocator Sontex 868 X with optical interface, standard device to substitute Kundo 201 / 202 devices.

For each version of heat cost allocator, it is possible to plug the connector of the remote sensor to an interface inside the heat cost allocator. Refer to chapter 2.3 Mounting the Remote Sensor. Once equipped with a remote sensor, the heat cost allocator will only work for an application with remote sensor.

Remote sensor version with 2 m cable.

1.1.7 Optical Interface

With a standardised optical probe the consumption and configuration values can be transferred directly to a computer. With the radio heat cost allocator **566 / 868** all consumption values can thus be readout over the optical interface and over radio. The data are transmitted in M-bus-format acc. to EN136757-3. Authorised personnel can alter the configuration of the device over the optical interface with an optical probe.

1.1.8 Radio Transmission

The radio heat cost allocator **566** features a transceiver circuit in the 433 MHz band with integrated antenna.

With the Sontex radio system, proven since more than 15 years; it is possible to readout the consumption values via a mobile radio modem or via a radio central installed directly in the office.

The Sontex radio system is a bidirectional system, i.e. the radio heat cost allocator is only called from a mobile PDA or a radio central upon request to send its data.

It is a great advantage that this system allows the alteration of the parameters over radio.

- Please refer to chapter **1.7.3 Operation Mode for Radio Supercom (Sontex 566 Radio)** for the radio reading range.

1.1.9 Radio Transmission wM-Bus

The radio heat cost allocator **868** features a transmitter circuit in the 868 MHz band with integrated antenna.

This radio module comprises a unidirectional radio transmitter which is used to transfer data according to the wM-Bus (EN 13757-4) radio communication protocol and in compliance with the OMS (Open Metering System) Release V3.0.1.

- Please refer to chapter **1.7.4 Operation Mode for Radio wM-Bus (Sontex 868 Radio)** for the radio reading range.

1.2 Operating mode

1.2.1 Cycle Time

The heat cost allocators **565 / 566 / 868** operate in a cycle of 4 minutes. Most of the time, the device is in sleeping mode. Every 4 minutes the device is set into operation and operates according to the adjoining diagram.

The clock-pulse generator is a counter which is completely independent from the rest of the program. This counter is designed in a way so that it is impossible to stall the cycle or to skip one or more cycles.

Each cycle follows the adjoining diagram. The measuring and calculating processes are explained in detail later.

The tasks carried out during one cycle are taking approx. 100 ms. This means that the device is in sleeping mode more than 99.8 % of the time. It can be set into operation between two cycles over the optical probe or by pushing the button. In this case it carries out the requested task and then returns to sleeping mode.

In case an optical probe is connected or the button is pushed during the course of the cycle, the respective value is readout at the end of the cycle.

The button can be pushed for an indefinite period of time and the optical probe can be left in its position since the normal function of the device is not impaired by an influence from outside.

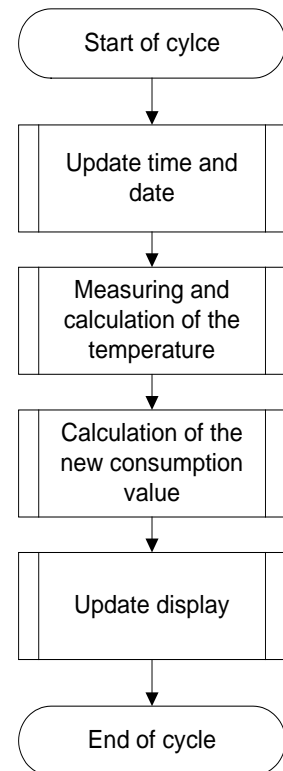

1.2.2 Single Sensor Version with Start Sensor

The start sensor of the single sensor version serves as an ambient temperature sensor which mainly functions during the heating up period.

The start temperature is the threshold temperature of the radiator at which the device always starts to carry out energy ratings. For these ratings, the measured radiator temperature and an assumed ambient temperature of 20° C are used as calculation basis.

1.2.3 Double Sensor Version

For the double sensor version basically the same specifications apply as for the single sensor version with start sensor. However, for calculating the room temperature the real temperature, measured by the ambient temperature sensor (corrected via the corresponding radiator-dependent „K_{air}-value“), is used as the basis.

1.2.3.1 Heat Accumulation Mode

In order to avoid faulty measuring due to heat accumulation (e.g. in case the radiator is hidden by panels), the device switches from a defined ambient temperature (e.g. 28°C) to the one sensor mode and calculates with an ambient temperature of 20° C.

1.2.4 Comparison of the Measuring Principles

Single sensor device with start sensor measuring principle

For heating systems with $t_{m_{min}} \geq 55 \text{ °C}$

The heat cost allocator calculates with a set reference temperature of 20 °C

Application:

Single sensor devices with start sensor are used in areas where normal ambient temperatures are given. For low temperature heating systems the double sensor device is recommended.

For radiators which are covered or blocked by fixtures, normally the single sensor devices are used because the double sensor device is not in a position to capture the current ambient temperature due to the heat accumulation.

Double sensor measuring principle

For heating systems with $t_{m_{min}} \geq 35 \text{ °C}$

The heat cost allocator calculates with a variable reference temperature $T_{air \text{ temperature}}$

Application:

Double sensor devices are used in areas where precise measuring of the ambient temperature is necessary and/or in low temperature heating systems.

Radiators which are covered or blocked by fixtures are detected automatically by the double sensor system which then switches over internally to the single sensor mode.

Within one billing unit, only one measuring principle (either single sensor measuring principle with start sensor or double sensor measuring principle) can be used. Mixed fitments or the use of different types of devices in the same billing unit is therefore also not allowed.

The processes for determining the K-value for the single sensor device with start sensor and the double sensor device are identical. It is only the measuring principle that is different.

1.2.5 Temperature Measurement and Calculation

The temperature is measured with an NTC – resistor. For the resistance measurement the discharging time of the capacitor is measured. The measurement is carried out as follows:

1.2.5.1 Measuring of a Resistor, Principle

1. Charging of the capacitor
2. Discharging of the capacitor through the resistance which is to be measured. At the same time a 16+1 bit-timer starts with the discharge to measure the discharging time
3. As soon as the voltage on the capacitor terminals reaches a certain value, an interrupt is induced and the timer stops. At the same time the discharging of the capacitor is stopped as well.

After the three mentioned stages, the timer provides a 16-bit-value which corresponds to the discharging time of the capacitor through the resistance which is to be measured. In case the resistance is known (reference resistance), the constant ratio between discharging time and resistance can be assessed.

1.2.5.2 Calculation of the Value of an Unknown Resistance (e.g. sensor resistance)

The capacitor C is loaded at constant current. The interrupt at the end of the discharge is triggered by the same threshold voltage (a fraction of the discharge voltage). If these two conditions are met, the discharge time is directly proportional to the resistance. With a reference resistance R_{ref} whose

exact value is known, it is now possible to calculate the unknown resistance value R_x with the following equation:

$$\frac{t_{ref}}{R_{ref}} = \frac{t_x}{R_x} \Rightarrow R_x = \frac{t_x}{t_{ref}} \cdot R_{ref}$$

From this equation the self-calibration of the converter can be derived, which is given by measuring the discharging time through the reference resistance.

1.2.5.3 Measuring of the Radiator and Ambient Temperature

The following measurements are carried out during one cycle:

1. Measuring of the reference resistance R_{ref}
2. Measuring of the ambient temperature sensor NTC_A
3. Measuring of the radiator temperature sensor NTC_R

The measuring values are calculated with the following formula:

$$NTC_A = \frac{t_{NTC_A}}{t_{ref}} \cdot R_{ref} \quad NTC_R = \frac{t_{NTC_R}}{t_{ref}} \cdot R_{ref}$$

The reference resistance value is defined ex works with a tolerance of 0.5% with 50 ppm. The reference resistance features an excellent temperature and long-term stability.

The capacitor value and the threshold voltage have to remain stable over the whole cycle. However, they can vary at the medium- or long term without causing any failures because the self-calibration of the converter is repeated in every cycle while measuring the reference resistance.

1.2.6 Calculation of the Displayed Consumption Value

The value displayed on the heat cost allocator is calculated as follows:

Single sensor device

$$Q = Kc * Kq \int \left(\frac{T_H - 20}{60} \right)^{1.33} dt$$

Double sensor device

$$Q = Kc * Kq \int \left(\frac{T_H - T_A}{60} \right)^{1.33} dt$$

Explanation: T_H Temperature of the radiator surface in [°C]
 T_A Ambient temperature in [°C]
 Q Displayed consumption value, **without unit**
 Kc Factor that carries back the ΔT measured at a normalized value
 Kq Factor Kq is a numerical value of the nominal power of the radiator stated in [KW]

Unit scale: $Kc = 1$ and $Kq = 1$
Product scale: $Kc <> 1$ and $Kq <> 1$

1.2.7 Start of Counting

The updating (increment) of the consumption value is carried out under the following conditions:

During winter period (heating period):

$$(T_R \geq 25 \text{ °C})$$

Or

$$(T_R \geq 20 \text{ °C}) \text{ AND } (T_R - T_A \geq \Delta T_{MIN})$$

During summer period (off heating period):

$$(T_R \geq 35 \text{ °C})$$

Or

$$(T_R \geq 20 \text{ °C}) \text{ AND } (T_R - T_A \geq \Delta T_{MIN})$$

Explanation: T_R Radiator temperature
 T_A Ambient temperature
 ΔT_{MIN} Minimum temperature difference between radiator and room
 3K for standard device (winter heating period standard setting)
 4K for remote sensor device (summer heating period standard setting)

Note:
 The thresholds of starting (25°C et 35°C) are indicative values. These temperatures of starting are adjusted according to the needs and specificities of the customer.

1.3 Display and Additional Functions

1.3.1 The Menu Sequences of the Digital Display

The menu sequences

Ex factory all menu sequences are activated. With the software **Prog6** the order of the menu sequences 1 - 15 can be changed in any order. However the order within the individual menu sequences 1 – 15 cannot be changed. It is also possible to hide individual menu sequences so that they are not visible to the end-user. When reading out over the optical interface or via radio the complete set of data is always readout and transferred.

Operation of the Push Button

When pushing the button briefly the digital display always goes to the next menu sequence.

When pushing the button in one menu sequence for 2 seconds the individual values within the selected menu sequence can be accessed. When the last value within one menu sequence has been displayed, the 1st position will be displayed by pushing the button again. If the button is not pushed for 2 minutes, the digital display returns to the cumulated consumption value.

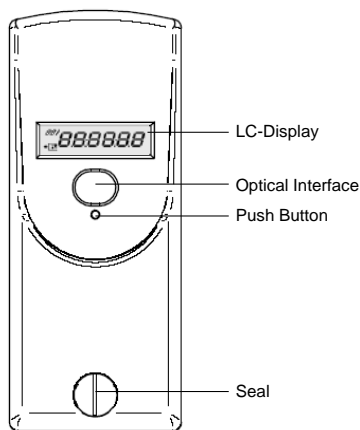
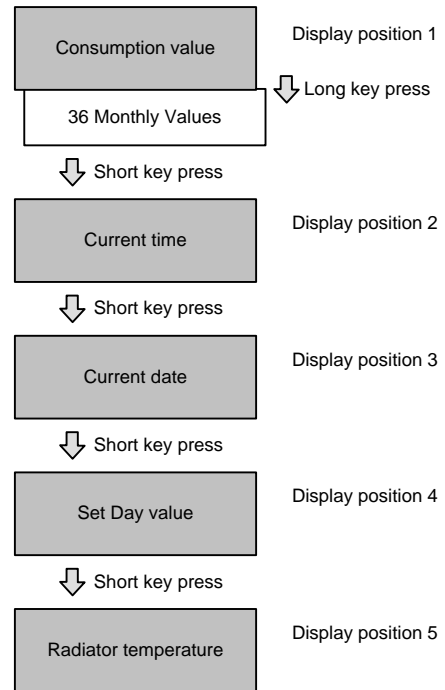

1.3.2 The Digital Displays

During normal operation the display is deactivated and can be activated by pushing the button. If the button is not pushed, the display will be active for 2 minutes only.

On request, the heat cost allocator is also available with permanent display 24h/24h or with a rolling menu displayed.

Consumption Value Unit Scale

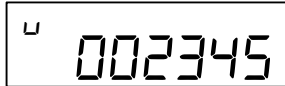

On the display of the heat cost allocator with unit scale an index **u** for unit is shown on the left side. If the index **u** is not displayed, the heat cost allocator is equipped with the product scale.

Consumption Value Product Scale

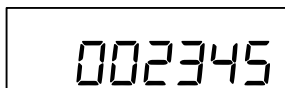

When commissioning the device this value is 000000. When reaching the value 999999, the counting restarts automatically at 000000.

Display in Euro



The heat cost allocators 6556/566/868 have the option to display the heating cost in Euro.

The cost in Euro indicated on the display is only approximate and is based on historical values from the previous year.

The displayed cost does not necessarily represent the charges to be paid.

Manufacturer and supplier decline any claims concerning the use and interpretation of the indicated values.

This option can be activated via the software **Prog6**.

Set day Value

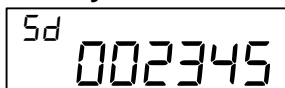

With the index **Sd** the consumption value recorded at midnight of the set day is displayed.

The consumption value recorded can be in unit scale or in product scale. It's depending of the unit setting.



If a new device has not yet reached the programmed set day, 000000 is displayed.

Check code

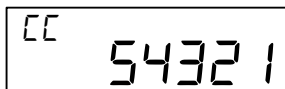

With the index **CC** the check code for the plausibility check of the manual readout is displayed.

Time

14h27

The current time (**always winter time**).

Date

29.05.15

The current date of the heat cost allocator.

Set Day

^{5d} 29.05.--

It is possible to program an annual set day on which the cumulated consumption value as well as the maximal radiator temperature are recorded.

With the index **5d** the programmed annual set day is displayed.

Date of Opening of the Device

^{od} 29.05.15

Each heat cost allocator is equipped with a manipulation protection which detects an unauthorised opening of the device after installation to the radiator. The date of the last opening of the device is recorded and displayed with the index **od**.

Commissioning Date

^{cd} 02.06.15

With the index **cd** the commissioning date is displayed, i.e. the date on which the device has been activated by pushing the button or during the mounting of the aluminium back plate if the function automatic commissioning is set.

Cumulated Duration of the Opening of the Device

^{du} 1568

With the index **du**, the cumulated duration in minutes during which the device was opened is detected. This display turns up only after commissioning in case the heat cost allocator was opened or removed.

Fraud Counter

^{fc} 32

This value indicates how many times the fraud / manipulation was activated.

Identification Number

¹⁵ 123456

With the index **15** an 8 digit identification number is displayed. Ex factory the serial number is identical with the identification number. The first two digits of the identification number are the two small digits on the left upper side of the digital display.

Running Hours

^{rh} 158

With the index **rh**, the running hours is displayed. This value can be compared to the battery use duration.

Monthly Values

01 002345

36 002345

The cumulated consumption values are recorded automatically at midnight on the last day of each month.

Number of monthly values: 36

The small digits on the upper left side show the number of previous monthly values. Digit 01 stands for the recent full month and digit 36 stands for the least recent month. All monthly values are set to 000000 when the device is commissioned.

Note 566 radio :

The radio heat cost allocator 566 only transmits the first 18 monthly values via radio telegram.

Note 868 radio :

Short telegram, OMS compliant: no monthly values transmitted via radio telegram.

Long telegram for **Walk-by reading**, the first 18 monthly values transmitted via radio telegram.

Half Monthly Values

41 002345

58 002345

The cumulated consumption values are recorded automatically at midnight on the 16th of each month.

Number of monthly values: 18

The small digits on the upper left side indicate the number of half monthly values. Digit 41 stands for the recent half monthly value and digit 58 for the least recent half monthly value. All half monthly values are set to 000000 when the device is commissioned.

Note 566 radio :

No half monthly values transmitted via radio telegram.

Note 868 radio :

Short telegram, OMS compliant and **long telegram** for **Walk-by reading**: no half monthly values transmitted via radio telegram.

Radiator Temperature

tr 68.9 °C

With the index **tr** the current radiator temperature is displayed.

Ambient Temperature

tA 25.7 °C

With the index **tA** the current ambient temperature is displayed.

Maximum Radiator Temperature of the Current Heating Period

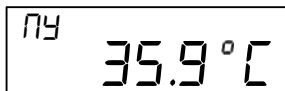

With the index **ny** the maximum radiator temperature of the current heating period (since the Set Day) is displayed.

Maximum Radiator Temperature of the Previous Heating Period

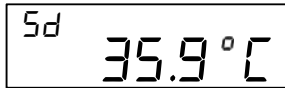

With the index **5d** the maximum radiator temperature of the previous heating period (before the Set Day) is displayed.

Monthly Value for Maximum Radiator Temperature

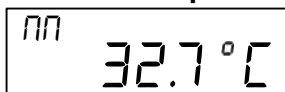

With the index **nn** the maximum radiator temperature of the currently month is displayed.

Number of monthly values: 18

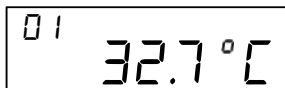

Recording of 18 monthly values for the maximum radiator temperature.

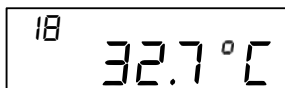

The small digits on the upper left side show the number of previous monthly values. Digit 01 stands for the recent full month and digit 18 stands for the least recent month. All monthly values are set to 000000 when the device is commissioned.

Software Version

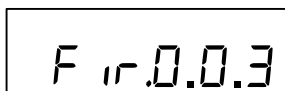

On the right side the software version x.x.x of the heat cost allocator is displayed.

Measuring Principle

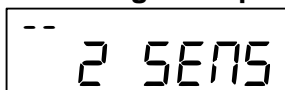

The index -- or **FF** indicates the type of the radiator sensor:

-- = Standard device, compact sensor.

FF = Remote sensor device, remote sensor.

1 SENS = single sensor device with start sensor.

2 SENS = double sensor device.

Segment Test

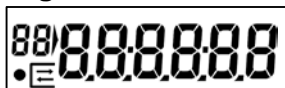

Segment test of the display.

Error Message

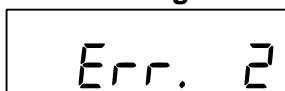

If an error is detected, **Err** is displayed in the first display sequence with the corresponding error message.

wM-Bus mode

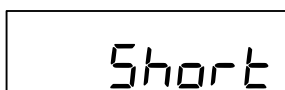

Telegram defined into heat cost allocator.

Type of telegram must be defined when ordering.

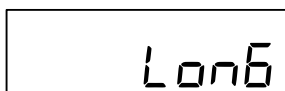

Short telegram (**Short**) used.

Long telegram (**Long**) used.

1.3.3 Rolling Digital Display

The EHCA 565, 566 and 868 also feature the possibility of a rolling display 24h/24h.

With the software **Prog6** or **Sontex916/ Tools916** or **Tools Supercom**, it is possible to individualize the rolling display.

Up to 15 parameters can be chosen optionally from the list below. These parameters can be combined in any order and are then shown on the rolling display.

- Consumption value.
- Time.
- Date.
- Set Day.
- Set Day value.
- 36 monthly values for cumulated consumption.
- 18 half monthly values for cumulated consumption.
- Radiator temperature.
- Ambient temperature.
- Identification number.
- Maximum radiator temperature of the previous heating period.
- Maximum radiator temperature of the current heating period.
- 18 monthly values for the maximum radiator temperature.
- Error code.
- Manipulation protection: storing of the duration of the last manipulation with date and the accumulated duration of all manipulations in minutes.
- Fraud Counter.
- Segment test.
- Software version.
- Running hours.
- Commissioning date.
- Measuring principle, single sensor device with start sensor or double sensor device.
- Short or long telegram for radio wM-Bus.

The duration of the display of the values can be chosen individually between **1 - 30** seconds.

Example:

Order and duration of display

- | | |
|--|--------|
| ■ Pos. 0 : Error (parameter ex factory, cannot be changed) (only displayed in case of an error message) | [5 s] |
| ■ Pos 1 : Time | [1 s] |
| ■ Pos 2 : Segment test | [5 s] |
| ■ Pos 3 : Consumption value | [10 s] |
| ■ Pos 4 : Set Day | [1 s] |
| ■ Pos 5 : Set Day value | [8 s] |
| ■ Pos 6 : Monthly value | [5 s] |
| ■ Pos 7 : Blank (therefore no display). | |
| ■ Pos 8 – Pos 15 : Blank (therefore no display. It is not necessary to occupy all positions). | |

The rolling display can also be deactivated by the **Prog6**, i.e. the device operates as in standard menu mode except that only these values and the values of the corresponding sub-menus that have been defined in the rolling menu can be displayed by pushing the button. After 2 minutes during which the button has not been pushed, the display goes out.

1.3.4 Communication Indicator and Measuring Indicator ●

The communication indicator displays if the heat cost allocator is currently making a calculation and/or if it communicates internally or externally over the optical or wireless interface (only radio Supercom).

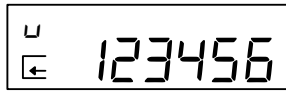

If the arrow of the communication indicator points inwardly internal communication takes place over the optical or wireless interface (only radio Supercom).

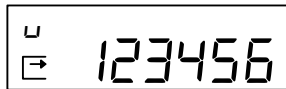

If the arrow of the communication indicator points outwardly external communication takes place over the optical or wireless interface (only radio Supercom).

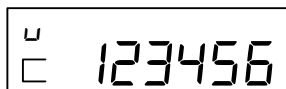

If the frame of the communication indicator appears the heat cost allocator has detected a wake-up signal (optical or radio Supercom)

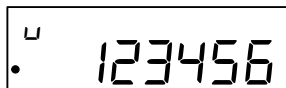

If the point indicator appears the heat cost allocator is carrying out a measuring or a calculation.

1.3.5 Real Time Clock and Calendar

The device has a 24 h real time clock and a calendar. However, the change from summer to winter time is not taken into account. The calendar is programmed until December 31 2099, including all leap years. The real time clock as well as the date of the heat cost allocator can be readout over the optical interface or via radio and if necessary be updated.

If the current date and time have to be updated over the optical interface or via radio, it is necessary to check the date of the computer first. Date and time of the device aim at those of the computer. If the reading/programming device (computer/PDA/ Smart Phone) has a wrong time, this time will be programmed into the heat cost allocator and suddenly no longer be reached at the usual time, because the time of the heat cost allocator possibly is shifted by several hours.

1.3.6 Readout

The current and monthly values recorded by the heat cost allocator **565 / 566 / 868** as well as several other parameters can be readout over the optical interface or also over radio.

The following parameters are transmitted:

Optical Interface:

- Identification number (information in header).
- Date and time.
- Consumption value.
- Set Day.
- Set Day value.
- Maximum radiator temperature of previous heating period.
- 36 monthly values and 18 half monthly values for cumulated consumption.
- 18 monthly values for the maximum radiator temperature.
- Rating factor K_C .
- Rating factor K_Q .
- Current radiator temperature.
- Current ambient temperature.
- Maximum radiator temperature of the current heating period.
- Manipulation protection:
 - Duration of the manipulations.
 - Date of the last manipulation.
 - Manipulation counter.
- Error code.
- Firmware version.
- Commissioning date.
- State of parameters.
- 36 half monthly values for the average ambient temperature.

Sontex 566 Radio Supercom :

- Identification number (information in header).
- Date and time.
- Consumption value.
- Set Day.
- Set Day value.
- Maximum radiator temperature of previous heating period.
- 18 monthly values for cumulated consumption.
- Rating factor K_C .
- Rating factor K_Q .
- Current radiator temperature.
- Current ambient temperature.
- Maximum radiator temperature of the current heating period.
- Manipulation protection:
 - Duration of the manipulations.
 - Date of the last manipulation.
 - Manipulation counter.
- Error code.
- Firmware version.
- Commissioning date.
- State of parameters.
- 36 half monthly values for the average ambient temperature.
- Cost per unit totalized.
- Parameter for Auto-reset totalizer.
- Statistics counters for Radio.

The following parameters are transmitted by **Sontex 868 Radio WM-Bus**:

Short telegram, OMS compliant :

- Identification number (information in header).
- Date and time.
- Consumption value.
- Set Day.
- Set Day value.
- Error code.
- Current radiator temperature.
- Current ambient temperature
- State of parameters.

Long telegram for Walk-by reading:

- Identification number (information in header).
- Date and time.
- Consumption value.
- Set Day.
- Set Day value.
- 18 monthly values for the cumulated consumption.
- Rating factor K_C .
- Rating factor K_Q .
- Current radiator temperature.
- Current ambient temperature.
- Maximum radiator temperature of the current heating period.
- Maximum radiator temperature of the previous heating period.
- Manipulation protection:
 - Duration of the manipulations.
 - Date of the last manipulation.
 - Manipulation counter.
- Error code.
- Firmware version.
- Commissioning date
- State of parameters.

AES 128 bits encryption is available for all versions.

1.3.7 Check Code

A special additional feature of the electronic heat cost allocator **565 / 565 / 868** is the check code function for the postcard mail-in method.

With especially developed algorithms a 5 digit check code is generated out of several device data. With this check code the values stated on the postcards mailed-in by tenants can be cross checked.

For this check, the following parameters are required:

- Identification number.
- The date.
- The current consumption value.
- The check code.

For the verification of the check code Sontex places all necessary tools (programs, formulas) at the disposal of the authorized personnel.

1.3.8 Change of Battery

The battery of the heat cost allocator is soldered. The lithium battery is not rechargeable. A change of battery is not planned. Therefore the heat cost allocators have to be replaced after 10 years.

Disposal

It is mandatory to dispose of the heat cost allocator environmentally friendly or to return it after use to the manufacturer for appropriate disposal to ensure that the components are recycled in accordance with the battery and electronic scrap regulations. Should you do the disposal yourself please get information from your local authority on the recycling possibilities



1.3.9 Protection against Outside Influences

1.3.9.1 Seal

The heat cost allocator is closed with a seal which cannot be removed without damaging it. Thus it is impossible to open the device unnoticed.

After installation, the electronic part of the device is no longer accessible. The digital display, the push button and the optical interface are covered by a sight glass. It is impossible to access the inside of the device through these openings without damaging the sight glass.

1.3.9.2 Electronic Detector in Case of an Opening of the Device

The electronic detector detects unauthorised opening, removing and closing of the heat cost allocator. As soon as the housing of the heat cost allocator is opened and/or removed, the electronic detector triggers an error message. The duration of each opening is counted, cumulated and only the last date of opening recorded.

1.4 Special Functions

1.4.1 Suppression of Summer Counting

The period during which summer counting is suppressed can be programmed by the software. If the heat cost allocator is in the period of summer counting suppression, consumption measuring is deactivated. If an automatic readout is carried out during this period the temperatures can be read anyway since the temperature measuring is still active.

1.4.2 Annual Reset of the Consumption Value

The function of the annual reset of the cumulated consumption value can be programmed by the software over the optical interface. One of the following options can be chosen for the reset:

- Set Day
- Never

Please note that only the cumulated consumption value is reset. All other values are not reset.

1.4.3 Unit Scale and Product Scale

For the heat cost allocators Sontex **565 / 566 / 868**, distinction is made between the unit scale and the product scale.

If heat cost allocators are used with the same scale on all radiators, this scale is called unit scale. The display values are the same on the different radiators if the heat cost allocators are exposed to the same temperature for the same period of time.

The evaluation of the display values is carried out arithmetically with the rating factors of the calculation software to receive the final consumption values.

1.4.3.1 Advantages of the Unit Scale

- Easy and quick installation of the heat cost allocator, no programming necessary.
- Possible errors by doing the scaling on site are avoided due to allocation by experts.

With the product scale, the radiator rating data are programmed in the heat cost allocator on site. The overall rating factor total (K_{Total}) is calculated directly in the heat cost allocator and thus the consumption value is displayed immediately.

1.4.3.2 Advantages of the Product Scale

- The actual consumption of each consuming point within one billing unit can be compared easily and quickly on site.

1.5 Parameterization

The software **Prog6** allows the parameterization over the optical interface.

To protect heat cost allocator against fraud, a password has been integrated into the **565 / 566 / 868** products, therefore also in the software. The default "installer" password ex-factory of the heat cost allocator is "00001234", and may be changed by the user.

1.6 Error

The heat cost allocator displays an error message with the 3 letters " Err. " and a code. If several errors occur at the same time, the different codes are added together.

The error is displayed in the first position of the display menu. It will still be possible to select all the other display menus by pressing the navigation button. If the navigation button is no longer pressed for a period of 2 minutes, the error code will automatically appear again in the first position of a display menu.

Display of an error automatically disappears when the error is no longer present.

1.6.1 List of Errors

- Err. 1 Manipulation (fraud).
- Err. 2 Measuring error.
- Err. 32 Push button constantly pushed.
- Err. 64 Measured temperature not within temperature range (0...105°C ; 0...120°C remote sensor).

1.7 Radio Standby – Radio-HCA 566 / 868

In order to achieve a user-friendly and power-saving radio standby, the radio heat cost allocator features the following different operating modes:

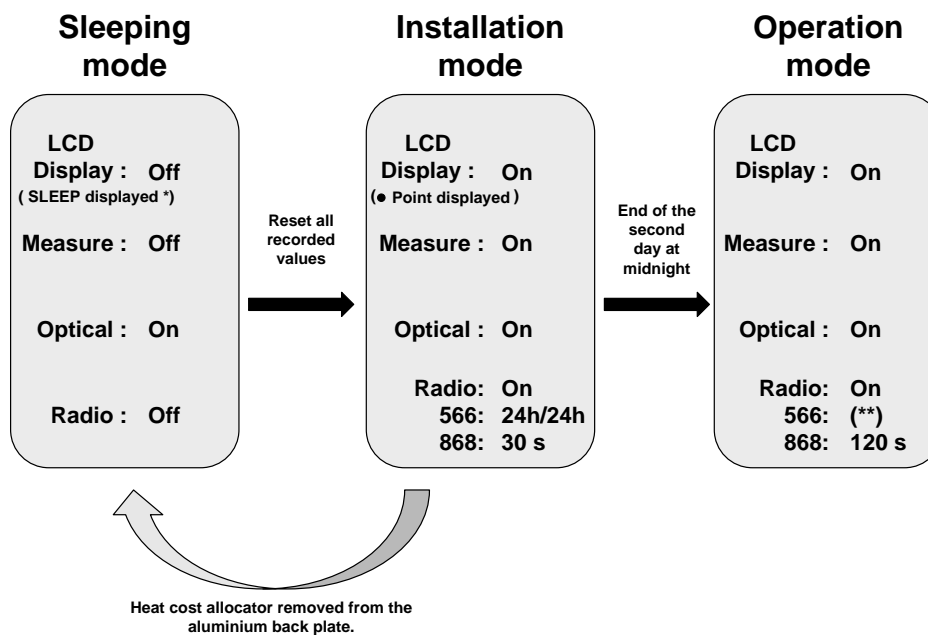

* : SLEEP information will be displayed by pushing the push button.

** : See also in chapter **1.7.3 Operation Mode for Radio Supercom (Sontex 566 Radio)**

Transition from sleeping mode to installation mode is achieved by two different ways:

1. Pushing the push button once the heat cost allocator is mounted on the aluminium back plate.
2. An automatic detection during the mounting on the aluminium back plate. This function must be specified at the order.

1.7.1 Sleeping Mode

Ex factory the radio heat cost allocator is in sleeping mode, but the internal clock and the date are running.

Current consumption is reduced to a minimum since no measuring and no calculations are carried out. Only the optical communication interface is available.

Transition from sleeping to installation mode is achieved by pushing the button once the heat cost allocator is mounted on the aluminium back plate or by an automatic commissioning during the mounting on the aluminium back plate (must be specified when ordering).

1.7.2 Installation Mode

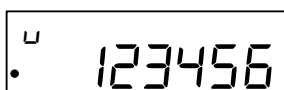

The ● symbol indicates that the heat cost allocator is in installation mode.

During the installation mode all functions of the radio heat cost allocator **566 / 868** are carried out.

- For heat cost allocator **566**, the radio transmission is possible 24h/24h till at the end of the second day at midnight. This guarantees an optimal availability of the radio heat cost allocator for test purposes during installation.

- For heat cost allocator **868**, an installation telegram is activated during the installation phase. Data are transmitted each 30 seconds (short and long telegram) till at the end of the second day at midnight.

The radio heat cost allocator **566 / 868** switches automatically into operating mode at the end of the second day at midnight.

If heat cost allocator is removed from the aluminium back plate during the installation mode, the heat cost allocator switches to the sleeping mode.

1.7.3 Operation Mode for Radio Supercom (Sontex 566 Radio)

1.7.3.1 Walk-by Radio Remote Readout

A walk-by remote readout of the data of the heat cost allocator 566 is possible **every day** from 6.00 to 17.59 (winter time).

No readout possible between 18.00 and 19.59 (winter time)

1.7.3.2 Readout over Radio Central (installed directly in the building)

For the readout over a radio central installed in the building, the following applies (see table below):

The device with the corresponding final numeral of the serial number is ready for radio transmission during the time stated in the table below.

| Time | Serial Number |
|------------------|---------------|
| 20 : 00 - 20 :59 | XXXXXXXX0 |
| 21 : 00 - 21 :59 | XXXXXXXX1 |
| 22 : 00 - 22 :59 | XXXXXXXX2 |
| 23 : 00 - 23 :59 | XXXXXXXX3 |
| 00 : 00 - 00 :59 | XXXXXXXX4 |
| 01 : 00 - 01 :59 | XXXXXXXX5 |
| 02 : 00 - 02 :59 | XXXXXXXX6 |
| 03 : 00 - 03 :59 | XXXXXXXX7 |
| 04 : 00 - 04 :59 | XXXXXXXX8 |
| 05 : 00 - 05 :59 | XXXXXXXX9 |

After readout of the data from the radio heat cost allocator, the radio availability is deactivated again.

1.7.4 Operation Mode for Radio wM-Bus (Sontex 868 Radio)

1.7.4.1 Readout over the *short telegram* (OMS compliant)

With this operating mode, the heat cost allocator Sontex 868 Radio transmits data:

- Transmission interval each **120 seconds** (minimum).
- Radio reading, **24h/24h**.

1.7.4.2 Readout over the *long telegram* for Walk-by reading

With this operating mode, the heat cost allocator Sontex 868 Radio transmits data:

- Transmission interval each **120 seconds** (minimum).
- Radio reading and periods, **12h per day (programmable), 5days/7days**.

1.7.5 Short Telegram or Long Telegram for Radio wM-Bus (868)

Type of telegram must be defined when ordering. There is no possibility to select the type of telegram directly on the heat cost allocator.

2. Installation

2.1 Introduction

To guarantee the proper functioning of the heat cost allocator **565 / 566 / 868**, it is of great importance that it is installed by an expert. On one hand, a constant heat transfer between radiator and heat cost allocator has to be guaranteed. On the other hand, the installation of the heat cost allocators on a large variety of radiator types should be as easy as possible.

The installation can be carried out in two different ways.

- The standard device is installed directly on the radiator.
- For the wall-mounted version the remote sensor is installed on the radiator and the heat cost allocator is wall-mounted.

For the installation of the heat cost allocators, special fastening-parts kits are available. To avoid faulty installation, we also recommend reading the Kc-data in the data base prior to the installation.

The heat cost allocator is an electronic device which – like all other similar devices – has to be handled with care. It is sensible to electric discharge and contacting certain areas of the PCB. Electric discharge can destroy the device or – even worse - damage it in a way that it fails after an indefinite period of time.

For this reason it is essential in any case to avoid contact with the PCB.

2.2 DIN Standard Requirements for the Installation

- Heat cost allocators can be installed in heating systems where the mean temperature is between the upper operating temperature limit t_{max} and the lower operating temperature limit t_{min} (t_{max} and t_{min} are stated in the technical data, see chapter 4 Technical Data)
- The installation of the devices has to be durable and avoid manipulations.
- The devices have to be installed in a place where sufficient correlation between the displayed value and the heat output of the radiator is given over a maximum operating range.
- Within a billing unit (in case of pre-distribution of the energy consumption: within a users' group) only heat cost allocators of the same manufacturer and the same type with identical rating systems may be used. Each device type has to be identifiable as such.
- Combinations of radiators and heat cost allocators with a measured value of $c > 0.3$ in basic condition are not permitted. In exceptional cases c-values of up to 0.4 are permitted within a billing unit if the concerned heating surface does not exceed 25 % of the overall heated surface or if the mean ambient temperature is above 80°C. Heat cost allocators may only be installed to radiators where the c-value is known at the time of billing.

2.3 Mounting the Remote Sensor

For each version of heat cost allocator, it is possible to plug the connector of the remote sensor into an interface inside the heat cost allocator.

The remote sensor will be automatically detected by the heat cost allocator.

Once equipped with a remote sensor, the heat cost allocator will only work for an application with remote sensor.

Remote sensor version with 2 m cable. The cable includes a stopper-knot.

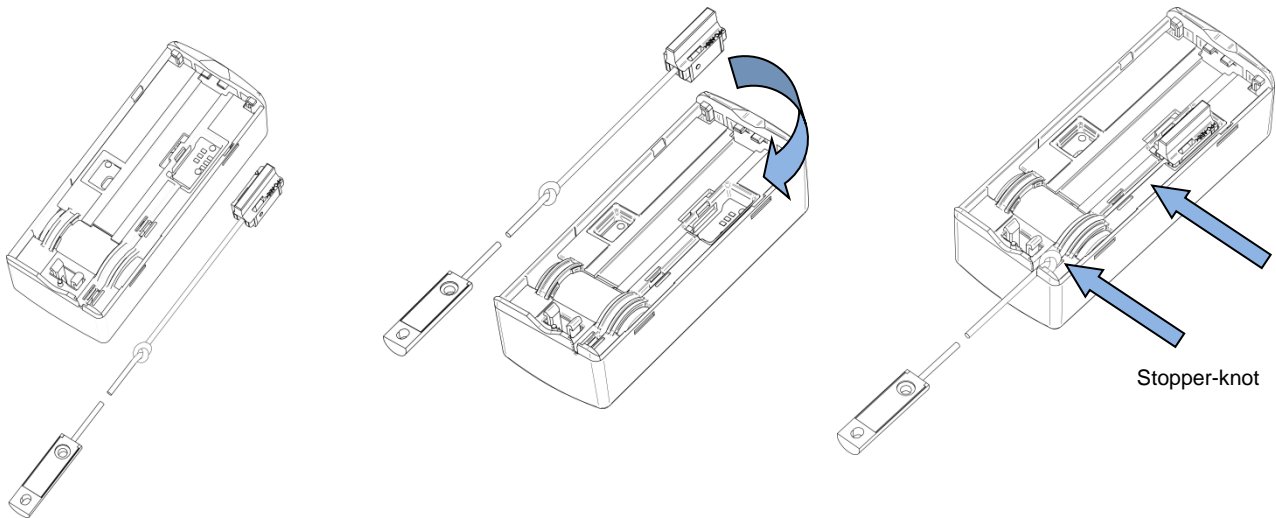

Return the heat cost allocator and plug the connector of the remote sensor into the interface inside the heat cost allocator.

Insert the remote sensor cable into the groove provided up to the slot of housing.

Place the stopper-knot inside the housing. The knot will avoid any traction on the connector.

Proceed to the commissioning of the heat cost allocator on the aluminium back plate. Take care not to stick the cable.

Respect the color code of the radiator sensor and the remote sensor:

- **Heat cost allocator Sontex 565 X, Sontex 566 X and Sontex 868 X:** the radiator sensor and the remote sensor are manufactured with a yellow color.
- **Heat cost allocator Sontex 565, Sontex 566 and Sontex 868:** the radiator sensor and the remote sensor are manufactured with a white color.

Once equipped with a remote sensor, the heat cost allocator will only work for an application with remote sensor.

If the remote sensor is disconnected from the heat cost allocator, an error message will be displayed.

During the commissioning of the heat cost allocator on the aluminium back plate, there are 2 possibilities to turn on the heat cost allocator:

1. By an automatic commissioning during the mounting on the aluminium back plate.
See chapter **3.1 Automatic commissioning during the installation**
2. By pushing the push button.
See chapter **3.2 Commissioning by pressing push button.**

2.4 General Restrictions

Electronic heat cost allocators cannot be used with steam heating, floor heating, ceiling radiant heaters, flap-controlled radiators and electrical radiator.

In case of combined valve- and flap-controlled radiators, the installation of an electronic heat cost allocator is only permitted if the flap control is dismantled or maintained in position „open“.

Convactor heaters where the performance can be altered by an electric blower as well as heat towel racks with an electric heating cartridge may only be equipped with an electronic heat cost allocator if the additional electric attachments are dismantled or shut down.

2.5 Operating Range

The Sontex heat cost allocators can be used in heating systems with the following mean heating medium temperatures:

For single sensor devices with start sensor

- 55°C...105° C for standard heat cost allocator.
- 55°C...120°C for wall-mounted heat cost allocator (remote sensor).

For double sensor devices

- 35°C...105° C for standard heat cost allocators.
- 55°C...120°C for wall-mounted heat cost allocators (remote sensor).

A heat cost allocator can be used in heating systems where the suitability of the system is in line with the operating conditions for which the heat cost allocator has been approved.

2.6 Mounting and Sealing

After installation of the respective fastening-parts kit to the radiator, the heat cost allocator can be mounted and sealed by the installer as described below:

The heat cost allocator is placed at the upper end of the aluminium back plate. Move the heat cost allocator down so that the hooks in the housing fit in the aluminium back plate.

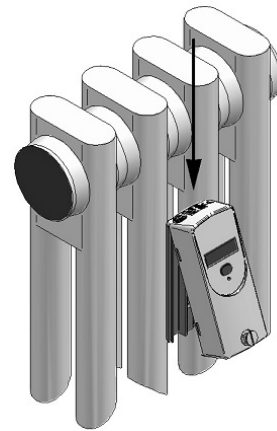

The heat cost allocator is placed on the aluminium back plate in the direction of the arrow.

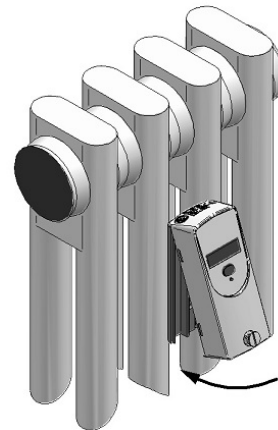

Push the seal pre-installed by Sontex in the slot of the housing, then press until the seal clicks into the aluminium back plate.

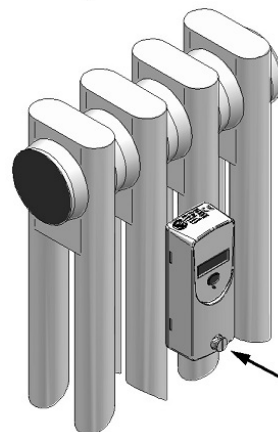

Now the heat cost allocator can only be opened by destroying the seal.

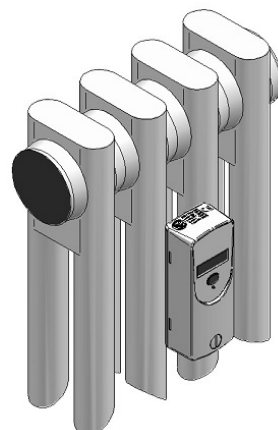

3. Commissioning

Ex factory the heat cost allocators **565 / 566 / 868** are in the so-called sleeping mode. In this mode no measuring is carried out and thus no consumption values are calculated. Furthermore the digital display, the radio communication options as well as the device opening detection are deactivated. Only the optical communication interface is available.

The date and time are running in the background.

Transition from sleeping to installation mode is achieved by pushing the button once when the heat cost allocator is mounted on the aluminium back plate or by an automatic commissioning during the mounting on the aluminium back plate.

After the commissioning and before leaving a new site, we recommend to perform a radio read out test and to create an installation protocol, to ensure that all the radio communication between the heat cost allocators and the radio central or radio modem was successful.

3.1 Automatic commissioning during the installation

Once heat cost allocator is fixed with/against the aluminium back plate, the LCD-display will show the following message:

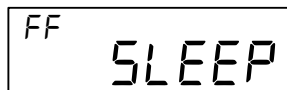

The index **FF** indicates that the heat cost allocator has recognized the remote sensor. If the remote sensor is not detected by the device, the index -- will be displayed.

The index -- indicates also a standard device with a compact sensor.

This message will be displayed during **5 seconds** and after that, the transition from sleeping mode to installation mode will be done automatically.

Transition from sleeping to installation mode is achieved automatically after 5 seconds:

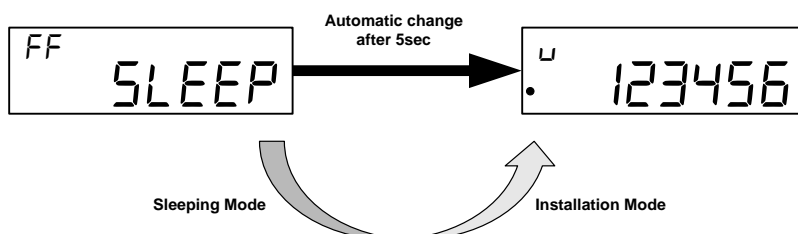

The **•** symbol indicates that the heat cost allocator is in installation mode.

Once installed on the back plate or the wall, the heat cost allocator switches automatically from the installation mode into the operating mode at the second transition of midnight.

3.2 Commissioning by pressing push button

Once heat cost allocator is fixed with/against the aluminium back plate, the LCD-display will show the following message:

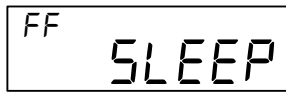

The index **FF** indicates that the heat cost allocator has recognized the remote sensor.
If the remote sensor is not detected by the device, the index -- will be displayed.

The index -- indicates also a standard device with a compact sensor.

This message will be displayed during **2 minutes** before the LCD-display will switch off.

Transition from sleeping to installation mode is achieved by pushing the push button during **3 seconds**:

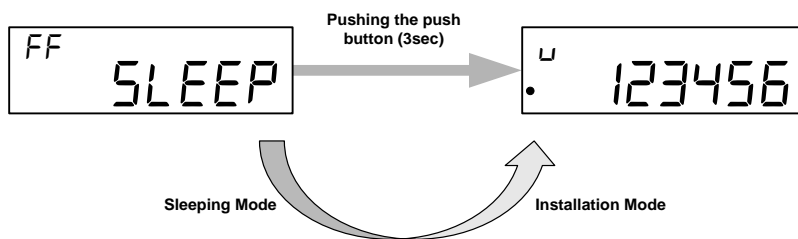

The • symbol indicates that the heat cost allocator is in installation mode.

Once installed on the back plate or the wall, the heat cost allocator switches automatically into operating mode at the second transition of midnight.

4. Technical Data

Optional measuring systems:

Single sensor device with start sensor
for heating systems with $t_{m_{min}} \geq 55 \text{ °C}$
Calculation with set reference temperature 20 °C
Necessary rating factors: KQ, KC, (KA, KT)

Double sensor device
for heating systems with $t_{m_{min}} \geq 35 \text{ °C}$
Calculation with variable ref. temperature T-air sensor
Necessary rating factors: KQ, KC, (KA, KT)

Optional scales:

Unit scale or product scale

Current supply:

3 V-Lithium-battery

Life-span with 1 battery:

> 10 years

Display:

Liquid crystal display (LCD-display)

No. of displayed digits:

6 digits (000000 ... 999999)

Sensor temperature range:

$0 \text{ °C} \dots 120 \text{ °C}$

Exponent:

$n = 1.33$

Radiator – performance range:

4 Watt ... 16.000 Watt

Design temperature range:

Single sensor device with start sensor

$(t_{m_{min}} \dots t_{m_{max}})$

$55 \text{ °C} \dots 105 \text{ °C} / 120 \text{ °C}$ (compact- / remote sensor)

Double sensor system

$(t_{m_{min}} \dots t_{m_{max}})$

$35 \text{ °C} \dots 105 \text{ °C} / 120 \text{ °C}$ (compact- / remote sensor)

K_C -values:

Rating factors see digital K_C -data base

Models:

Compact device or remote sensor device

Set day:

Freely programmable

Data storage:

144 monthly values and 18 half monthly values for cumulated heat consumption, 18 monthly values for the maximum radiator temperature. Maximum temperature of the current and previous year, all relevant consumption values

Self-test:

Before every measuring

Start of counting:

Heating period $25 \text{ °C} - 40 \text{ °C}$ (programmable)

Off-heating period $25 \text{ °C} - 40 \text{ °C}$ (programmable)

Standard version:

Acc. to EN 834

Homologation acc. to

HKVO: A1.02.2015

DIN registry No.:

291/08 E

Conformity:

CE

Standard mounting height:

At 75% of the overall height of the radiator.

If the height of the radiator is less than (<) 470 mm, the heat cost allocator must be installed at 50% BH. (in case of deviating mounting heights, please refer to this manual and the digital K_C -data base

Issue: Rév. 241016

Document: 0565P202 Installation guide line EHCA 565-566-868 24-10-2016

Technical modifications subject to change

Technical Support

For technical support contact your local Sontex agent or Sontex SA directly.

Hotline Sontex:

sontex@sontex.ch

+41 32 488 30 04

© Sontex SA 2016